

M12 系列

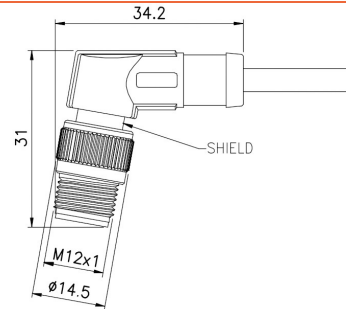

- M12 弯头连接器 注塑成型式
- 描述:M12 弯头连接器 注塑成型式 公头, 带屏蔽, 线缆长度可以定制, A/B/C/D 型号



接线颜色与线序

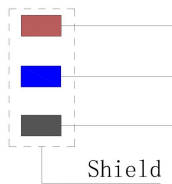

- 1 Brown
- 3 Blue
- 4 Black

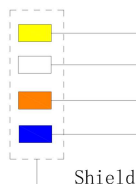

- 1 Yellow
- 2 White
- 3 Orange
- 4 Blue

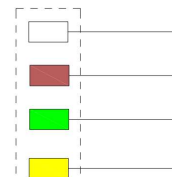

- 1 White
- 2 Brown
- 3 Green
- 4 Yellow
- 5 Gray

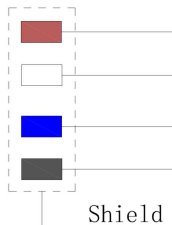

- 1 Brown
- 2 White
- 3 Blue
- 4 Black

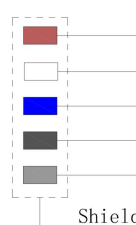

- 1 Brown
- 2 White
- 3 Blue
- 4 Black
- 5 Gray

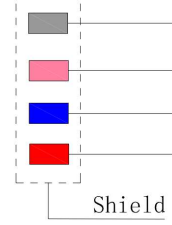

- 1 White
- 2 Brown
- 3 Green
- 4 Yellow
- 5 Gray
- 6 Pink
- 7 Blue
- 8 Red

技术参数

针数	3	4	5	8	12	17	5	4
型号	A	A	A	A	A	A	B	D
Pin位分布图								
类型	注塑成型							
额定电流	4A	4A	4A	2A	1.5A	1.5A	4A	4A
额定电压	250V	250V	60V	30V	30V	30V	60V	250V
工作温度	-25℃~85℃							
防护等级	IP67/IP68							
锁紧方式	焊接							
插拔次数	>500 次插拔循环							
触点电阻	≤10mΩ							
连接器材料	铜锌、TPU/PVC							
端子材料	Au (镀金)							
线材AWG	26AWG -22AWG /自定义							

订单信息

■ 料号	■ 型号
M12- <input type="text"/> -MR- <input type="text"/> - <input type="text"/> - <input type="text"/> -SH	RG121005
<div style="display: flex; justify-content: space-around; font-size: small;"> 型号 芯数 线长 线缆材料 </div>	
温馨提示:我们通常将线缆尾部长度剥皮 30mm。屏蔽线接触金属外壳。如果您有定制要求, 请随时联系我们。	

M5
M8
M9
M12
M16
M18
M23
7/8"
M Box
Value
RJ45
USB
D-SUB
RD24
RD30